

RCI CUSTOM

Custom Products

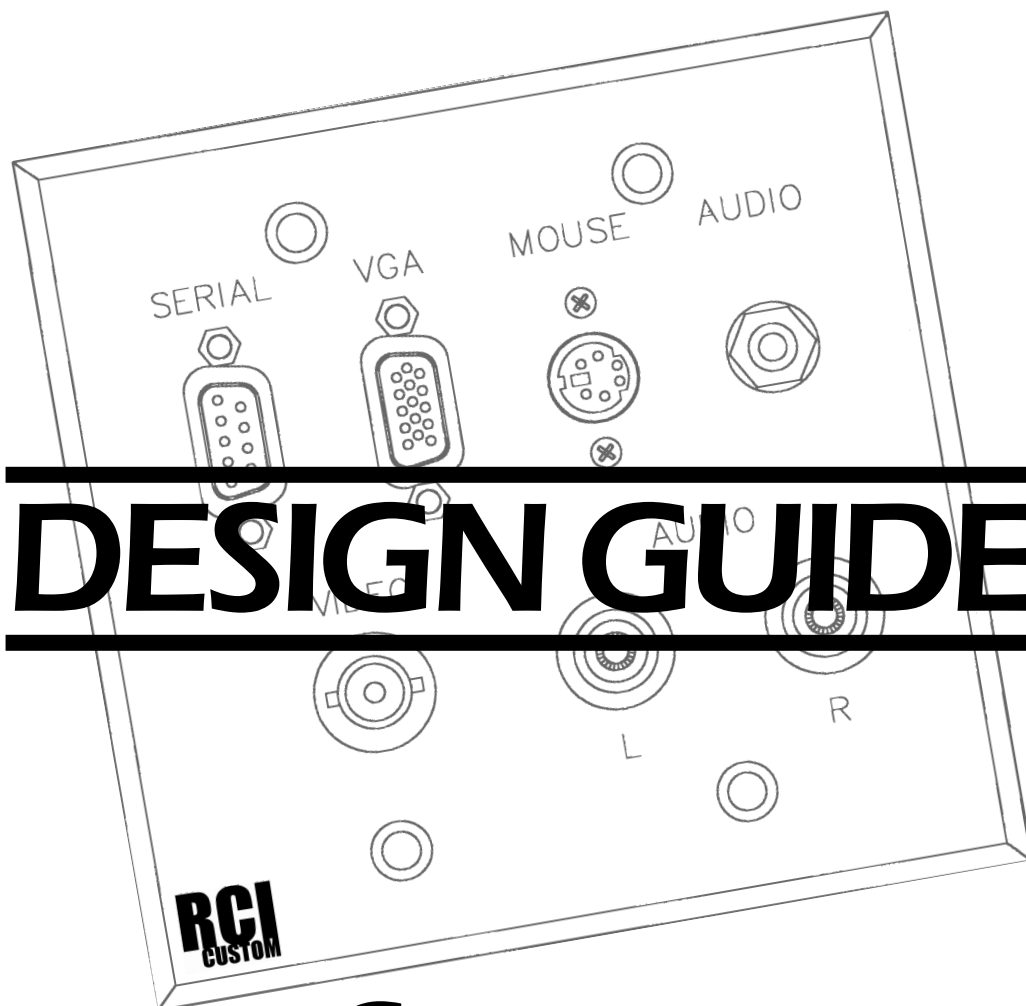

DESIGN GUIDE

Custom Plates and Panels

www.rcicustom.com

Table of Contents

Custom Design & Layout

Custom Graphics	3 & 4
Layout Instructions — Wall Plates	5
Wall Plate Design Template — One-Gang	6
Wall Plate Design Template — Two-Gang	7
Wall Plate Design Template — Three-Gang	8
Wall Plate Design Template — Four-Gang	9
Parts & Connectors Template	10 & 11
Layout Instructions — Rack Panels	12
Rack Panel Design Template — One Rack Space	13
Rack Panel Design Template — Two Rack Space	14
Rack Panel Design Template — Three Rack Space	15
Rack Panel Design Template — Four Rack Space	16
Rack Panel Design Template — Five Rack Space	17
Parts & Connectors Template	18 & 19
Custom Chassis	20

Presenting the RCI Custom Design Guide.

Simple and easy to use, the new RCI Custom Design Guide has been created through the suggestions, comments, and input of the many contractors and systems design engineers who rely on RCI Systems every day for what we really are - a "Custom Solutions" company.

Our design guide is set up to cater to the A/V contractors more common need for customized audio and video products. Easy step by step instruc-

tions, custom design templates and parts legends, and our experienced Customer Service Department will help you to create the perfect plate or panel every time.

Use this booklet as a catalyst for your own creativity. Some of our most successful standard products have been created from an idea for either improving an available product, or developing something new to solve an existing problem. With custom metal pro-

cessing, unlimited custom finishes, rack mount chassis, and engraving and silk screening services all available under one roof, almost anything is possible!

RCI wants to be the company you think of first for **any custom audio or video need**. While it is well known that we specialize in custom wall plates and rack panels, we welcome the opportunity to help you engineer, design, and fabricate just about any audio or video product you may need.

RCI Custom Products - your one stop "Custom Solution" shop!

Updates On The Web!

Get the most current version of the RCI Custom Design Guide by downloading it from the World Wide Web. It's Fast, Free and Easy!

www.rcicustom.com

RCI Custom
Products
CUSTOM

801 North East Street, Frederick, MD 21701 • PHONE 301-620-9130 • FAX 301-620-9103

1/99

Custom Design and Layout

The following custom design section was created as an aid to the more common need for custom audio and video plates and panels. Blank plate and panel design templates are provided, along with drawings of several of the most commonly used connectors and devices to help you throughout the design process.

HERE'S WHAT YOU DO.

- Make copies of the pages with blank plates and parts on them.
- Draw or trace the desired device onto the copy of the selected blank plate or panel, or —
- Cut and paste the desired device onto the copy of the selected blank plate or panel.
- Indicate the quantity, series, engraving, and finish requirements for each particular plate.
- Add any graphics information (i.e., logo placement or specialty graphics)
- Fax your drawing to RCI for a quote.

IT'S THAT SIMPLE!

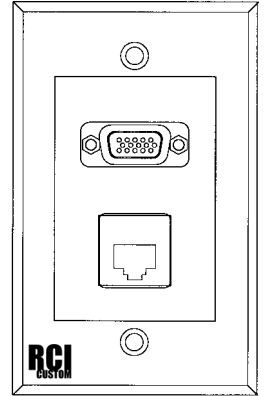

Computer Design

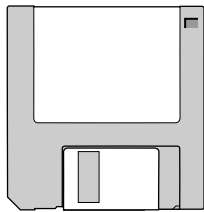

For those systems design consultants and established customers who prefer to create their custom plates and panels by computer, you may qualify for our CAD drawing files package. Please contact your local RCI Custom Products Sales Representative, or call RCI Customer Service at 1-800-546-4724 for details.

RCI Graphics

Add your company name, logo, service phone number or other information to your finished product, even on orders as small as five pieces! See page 4 for details on how easy it is to use silk screening, engraving and electro luminescence. Screen charges and per piece costs are available in our price list as well as by quote.



Custom Wiring

RCI can deliver your plates and panels complete with pigtails or pre-wired to connectors, ready for easy installation. Save time and money associated with labor costs by letting RCI's skilled technicians do the work for you. Simply provide your wiring requirements in writing and we'll do the rest.

For other wire or cable needs, consult our full line catalog or call an RCI Customer Service Representative at 800-546-4724.



For catalogs, literature, and the most current product information available, call or visit our website at:

www.rcicustom.com • 800-546-4724

Customize and identify your finished product with your company name or logo.

GRAPHICS

Graphics and text are the most obvious and notable custom option available to our customers. Professionally created and produced graphics add a “pro” touch to any plate or panel — a touch that says “quality” to the end user.

Use graphics in the form of engraving, silk screening, or illumination through electro luminescence. Graphics can be used to show the functionality of any plate or panel, to distinctly identify a project, or to subtly advertise your business with the display of your company logo, name, service contact information, or phone numbers.

Graphics and text are affordable even in small quantities, and can be added to nearly any custom product produced at RCI. Choose the graphics option that best suits your particular project, and let RCI do the rest!

Engraving

- Most cost effective for small runs or orders with changing or progressive graphic requirements.
- Permanent and durable
- Multiple font choices, as well as Braille available
- * Appropriate for basic logo reproduction

Silk Screening

- Most cost effective for large runs or similar product
- Consistent professional appearance
- Quick production time
- Excellent reproduction of complex and multicolored logos

Illumination / Electro Luminescence

- Clearly visible graphics in low light areas
- Perfect for theatres, conference & meeting rooms, production studios, etc.
- E.L. lamps far out last incandescent bulbs
- Can be powered with AC or DC voltage

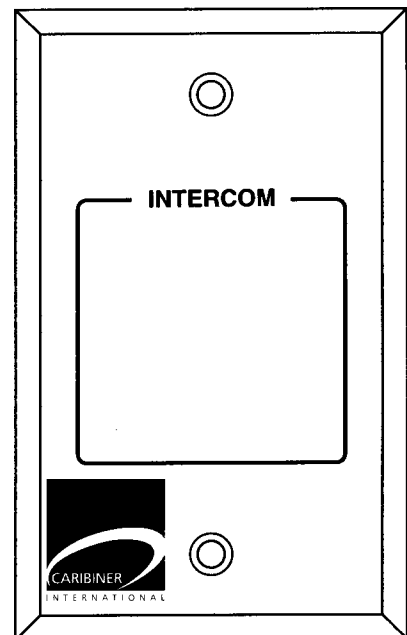

IT'S EASY TO CUSTOMIZE!

Simply send us your camera ready artwork (1:1 ratio or higher), and we'll do the rest! If you don't have camera ready art, call us for help. Graphics or text can be added to your order through RCI graphics services, at an additional cost. Single and multi-colored logo reproductions are welcome!



**For Updates &
Catalog Info ...**

www.rcicustom.com

STEP 1.

Make copies of wall plates and full scale symbols located on pages 10 & 11.

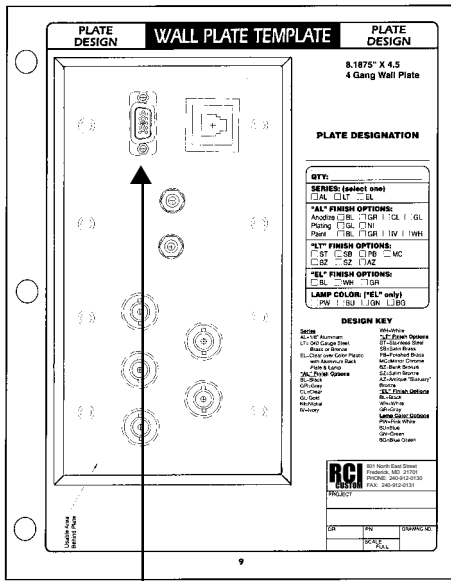

STEP 2.

Trace or Paste

Place the symbol page under the copy of the wall plate and trace the devices on the blank plate at the desired location
OR
 cut out the appropriate devices from the copy of the symbol page and paste them on the blank plate at the desired location.

Be sure to note device sizes and usable area of wall plate.

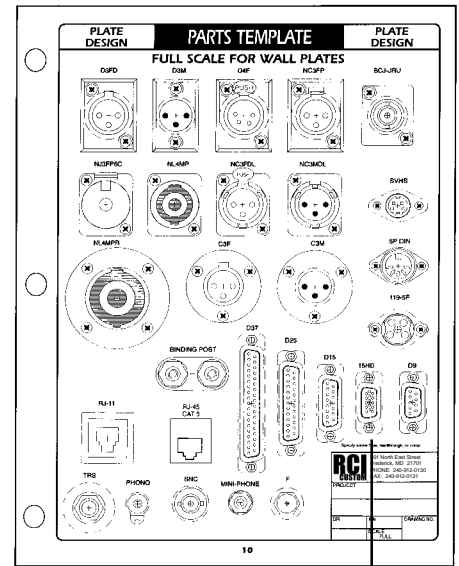

STEP 3.

Write in text to be engraved on plate. If the plate has multiple quantities, indicate subsequent engraving.

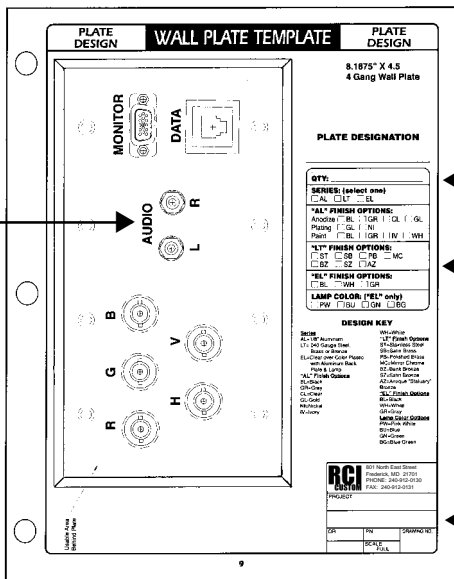

STEP 5.

Fax completed plate design to our AVD Sales Department for quotation.

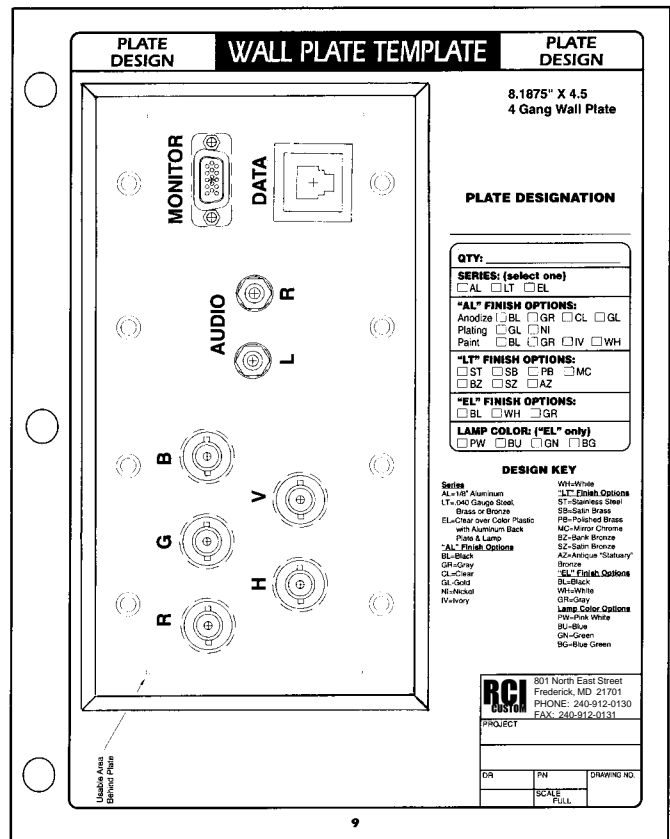

STEP 4.

Indicate plate designation, quantity, finish type, and any other additional engraving or silkscreening requirements. Fill title block with appropriate information, if desired.

Usable Area
Behind Plate

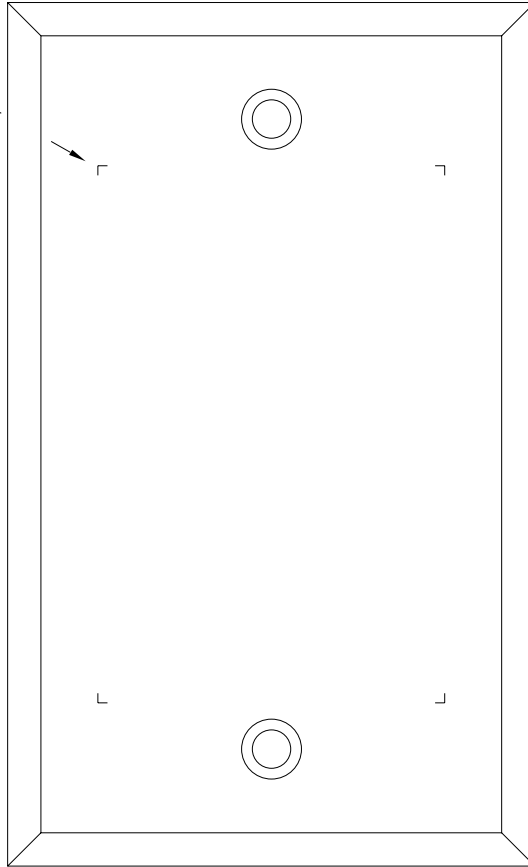

**2.75" X 4.5
1 Gang Wall Plate**

PLATE DESIGNATION

DESIGN KEY

Series
 AL=1/8" Aluminum
 LT=.040 Gauge Steel,
 Brass or Bronze
 EL=Clear over Color Plastic with
 Aluminum Back Plate & Lamp

"AL" Finish Options
 BL=Black
 GR=Gray
 CL=Clear
 GL=Gold
 NI=Nickel
 IV=Ivory
 WH=White

"LT" Finish Options
 ST=Stainless Steel
 SB=Satin Brass
 PB=Polished Brass
 MC=Mirror Chrome
 BZ=Bank Bronze
 SZ=Satin Bronze
 AZ=Antique "Statuary" Bronze

"EL" Finish Options
 BL=Black
 WH=White
 GR=Gray

Lamp Color Options
 PW=Pink White
 BU=Blue
 GN=Green
 BG=Blue Green

QTY: _____

SERIES: (select one)

AL LT EL

"AL" FINISH OPTIONS:

Anodize BL GR CL GL
 Plating GL NI
 Paint BL GR IV WH

"LT" FINISH OPTIONS:

ST SB PB MC
 BZ SZ AZ

"EL" FINISH OPTIONS:

BL WH GR

LAMP COLOR: ("EL" only)

PW BU GN BG

**RCI
CUSTOM** 801 North East Street
 Frederick, MD 21701
 PHONE 301-620-9130
 FAX 301-620-9103

PROJECT

DR	PN	DRAWING NO.
SCALE FULL		

**4.5" X 4.5
2 Gang Wall Plate**

Usable Area
Behind Plate

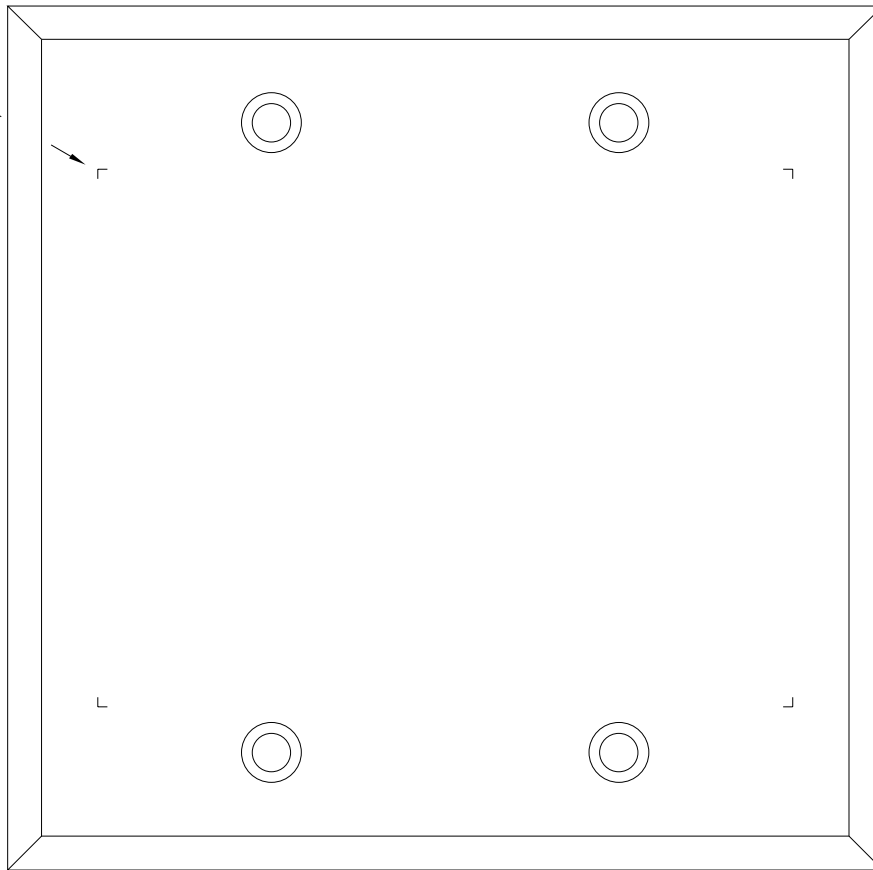

PLATE DESIGNATION

DESIGN KEY

Series

AL=1/8" Aluminum
 LT=.040 Gauge Steel,
 Brass or Bronze
 EL=Clear over Color Plastic with
 Aluminum Back Plate & Lamp

"AL" Finish Options

BL=Black
 GR=Gray
 CL=Clear
 GL=Gold
 NI=Nickel
 IV=Ivory
 WH=White

"LT" Finish Options

ST=Stainless Steel
 SB=Satin Brass
 PB=Polished Brass
 MC=Mirror Chrome
 BZ=Bank Bronze
 SZ=Satin Bronze
 AZ=Antique "Statuary" Bronze

"EL" Finish Options

BL=Black
 WH=White
 GR=Gray

Lamp Color Options

PW=Pink White
 BU=Blue
 GN=Green
 BG=Blue Green

QTY: _____

SERIES: (select one)

AL LT EL

"AL" FINISH OPTIONS:

Anodize BL GR CL GL
 Plating GL NI
 Paint BL GR IV WH

"LT" FINISH OPTIONS:

ST SB PB MC
 BZ SZ AZ

"EL" FINISH OPTIONS:

BL WH GR

LAMP COLOR: ("EL" only)

PW BU GN BG

RCI
CUSTOM
 801 North East Street
 Frederick, MD 21701
 PHONE 301-620-9130
 FAX 301-620-9103

PROJECT		
DR	PN	DRAWING NO.
SCALE FULL		

**6.375" X 4.5
3 Gang Wall Plate**

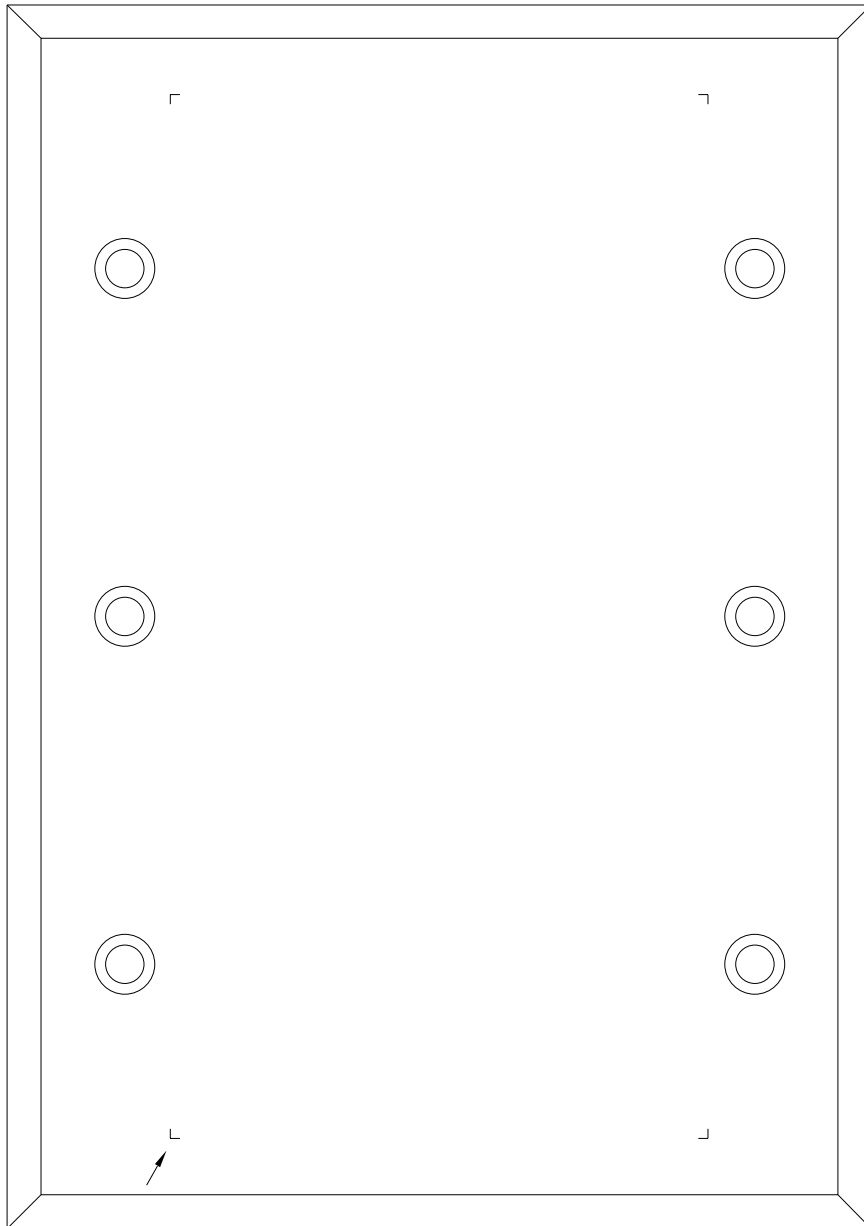

PLATE DESIGNATION

QTY: _____
SERIES: (select one) <input type="checkbox"/> AL <input type="checkbox"/> LT <input type="checkbox"/> EL
"AL" FINISH OPTIONS: Anodize <input type="checkbox"/> BL <input type="checkbox"/> GR <input type="checkbox"/> CL <input type="checkbox"/> GL Plating <input type="checkbox"/> GL <input type="checkbox"/> NI Paint <input type="checkbox"/> BL <input type="checkbox"/> GR <input type="checkbox"/> IV <input type="checkbox"/> WH
"LT" FINISH OPTIONS: <input type="checkbox"/> ST <input type="checkbox"/> SB <input type="checkbox"/> PB <input type="checkbox"/> MC <input type="checkbox"/> BZ <input type="checkbox"/> SZ <input type="checkbox"/> AZ
"EL" FINISH OPTIONS: <input type="checkbox"/> BL <input type="checkbox"/> WH <input type="checkbox"/> GR
LAMP COLOR: ("EL" only) <input type="checkbox"/> PW <input type="checkbox"/> BU <input type="checkbox"/> GN <input type="checkbox"/> BG

DESIGN KEY

Series

AL=1/8" Aluminum
 LT=.040 Gauge Steel,
 Brass or Bronze
 EL=Clear over Color Plastic with
 Aluminum Back Plate & Lamp

"AL" Finish Options

BL=Black
 GR=Gray
 CL=Clear
 GL=Gold
 NI=Nickel
 IV=Ivory
 WH=White

"LT" Finish Options

ST=Stainless Steel
 SB=Satin Brass
 PB=Polished Brass
 MC=Mirror Chrome
 BZ=Bank Bronze
 SZ=Satin Bronze
 AZ=Antique "Statuary" Bronze

"EL" Finish Options

BL=Black
 WH=White
 GR=Gray

Lamp Color Options

PW=Pink White
 BU=Blue
 GN=Green
 BG=Blue Green

Usable Area
Behind Plate

RCI CUSTOM		801 North East Street Frederick, MD 21701 PHONE 301-620-9130 FAX 301-620-9103
PROJECT		
DR	PN	DRAWING NO.
SCALE FULL		

**PLATE
DESIGN**

WALL PLATE TEMPLATE

**PLATE
DESIGN**

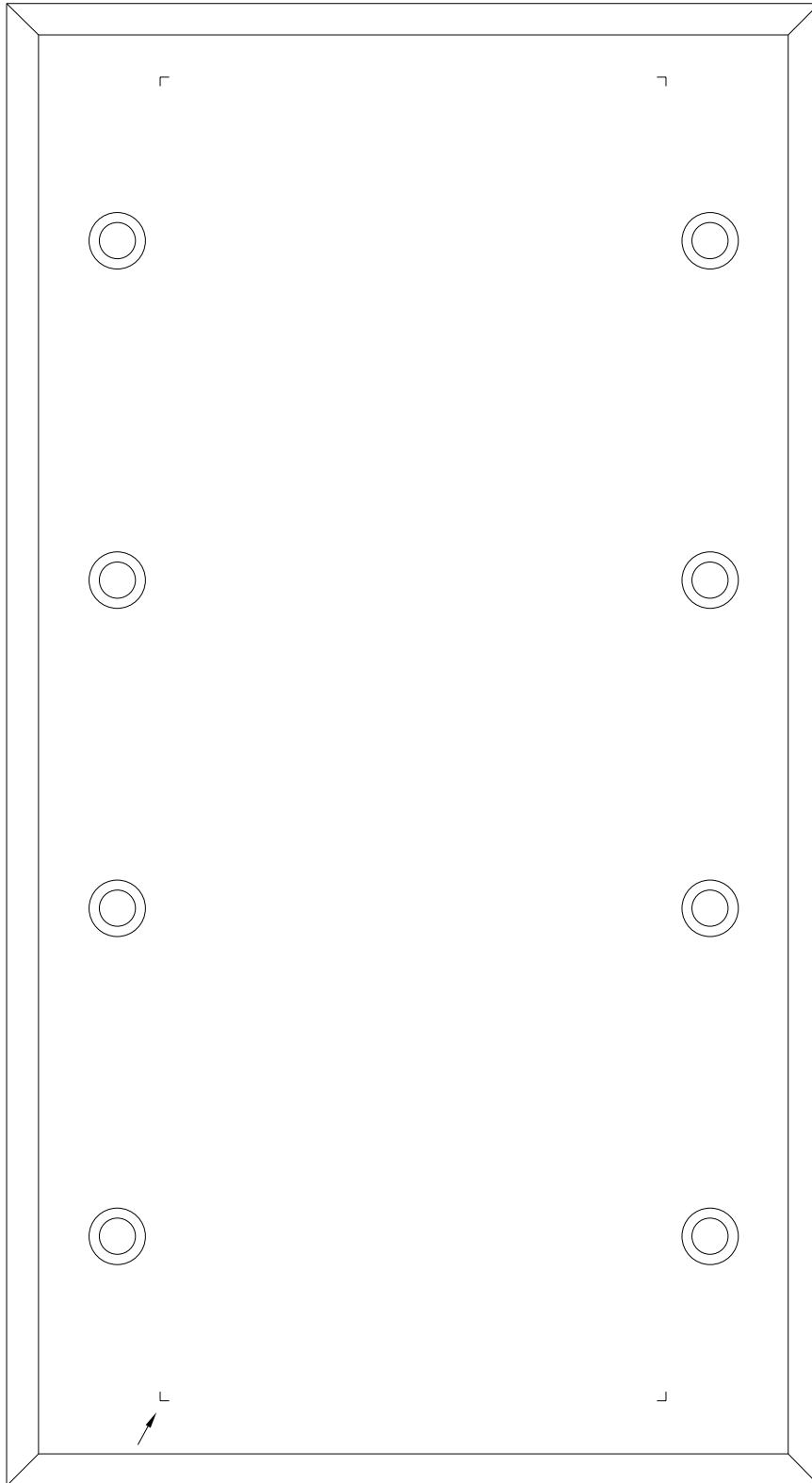

Usable Area
Behind Plate

**8.1875" X 4.5
4 Gang Wall Plate**

PLATE DESIGNATION

QTY: _____

SERIES: (select one)

AL LT EL

"AL" FINISH OPTIONS:

Anodize BL GR CL GL

Plating GL NI

Paint BL GR IV WH

"LT" FINISH OPTIONS:

ST SB PB MC

BZ SZ AZ

"EL" FINISH OPTIONS:

BL WH GR

LAMP COLOR: ("EL" only)

PW BU GN BG

DESIGN KEY

Series

AL=1/8" Aluminum
LT=.040 Gauge Steel,
Brass or Bronze
EL=Clear over Color Plastic
with Aluminum Back
Plate & Lamp

"AL" Finish Options

BL=Black
GR=Gray
CL=Clear
GL=Gold
NI=Nickel
IV=Ivory
WH=White

"LT" Finish Options

ST=Stainless Steel
SB=Satin Brass
PB=Polished Brass
MC=Mirror Chrome
BZ=Bank Bronze
SZ=Satin Bronze
AZ=Antique "Statuary"
Bronze

"EL" Finish Options

BL=Black
WH=White
GR=Gray

Lamp Color Options

PW=Pink White
BU=Blue
GN=Green
BG=Blue Green

**RCI
CUSTOM**

801 North East Street
Frederick, MD 21701
PHONE 301-620-9130
FAX 301-620-9103

PROJECT

DR

PN

DRAWING NO.

SCALE
FULL

FULL SCALE FOR WALL PLATES

D3FD

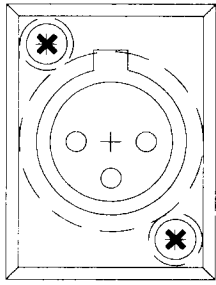

D3M

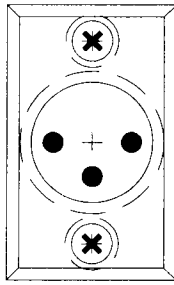

D4F

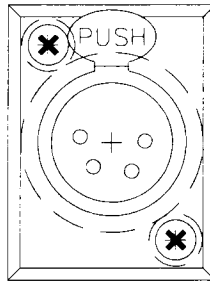

NC3FP

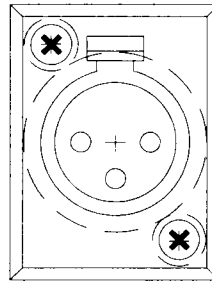

BCJ-JRU

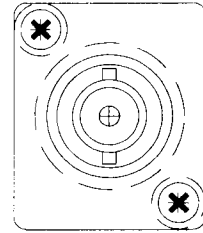

NJ3FP6C

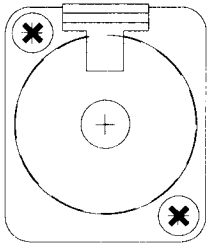

NL4MP

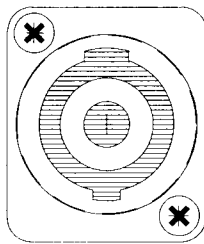

NC3FDL

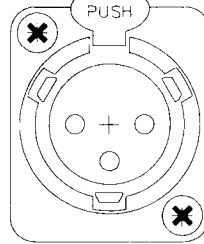

NC3MDL

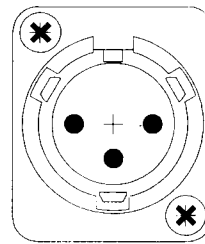

SVHS

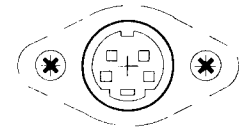

NL4MPR

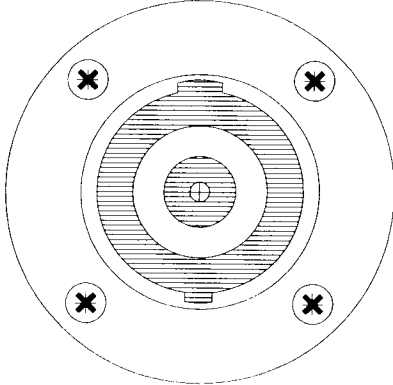

C3F

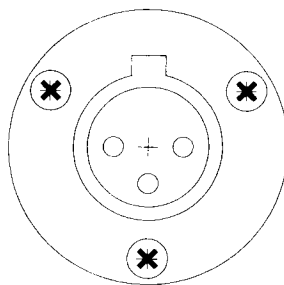

C3M

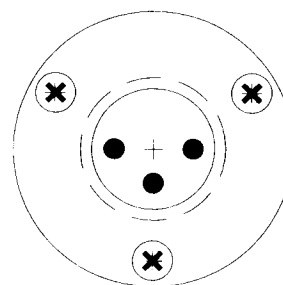

5P DIN

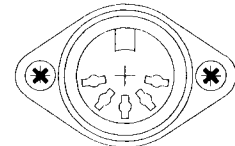

119-5F

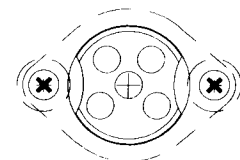

BINDING POST

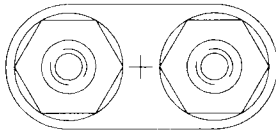

D37

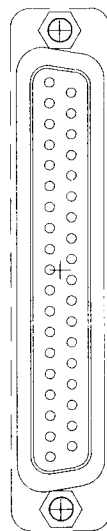

D25

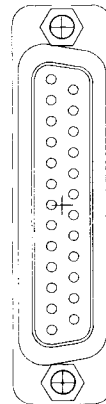

D15

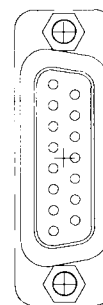

15HD

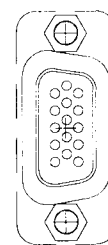

D9

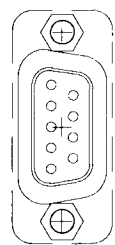

RJ-11

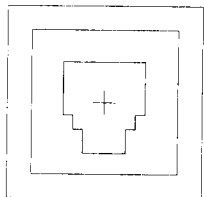

RJ-45
CAT 5

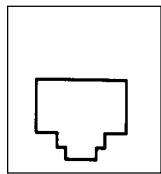

Specify solder type, feedthrough, or crimp.

TRS

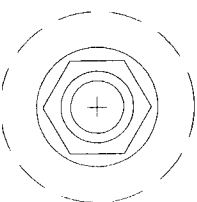

PHONO

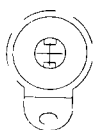

BNC

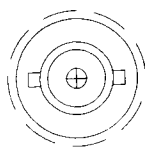

MINI-PHONE



F

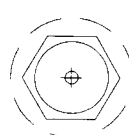

RCI
CUSTOM

801 North East Street
Frederick, MD 21701
PHONE 301-620-9130
FAX 301-620-9103

PROJECT

DR

PN

DRAWING NO.

SCALE
FULL

FULL SCALE FOR WALL PLATES

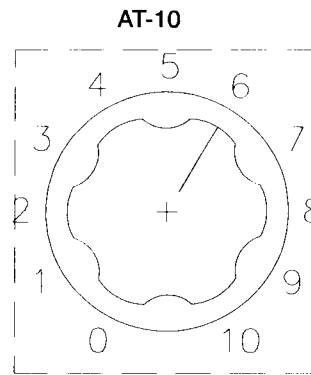
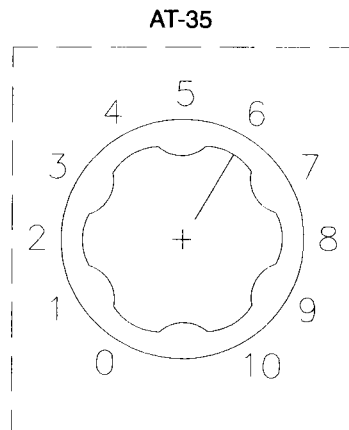
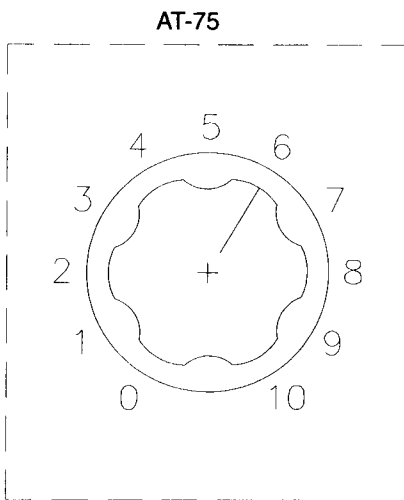
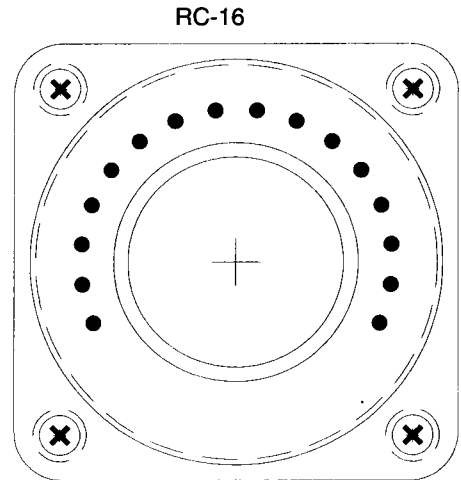
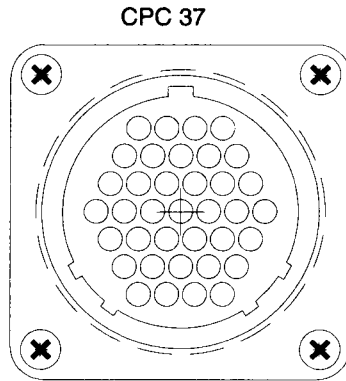
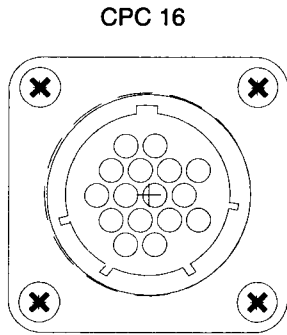

BARRIER STRIP

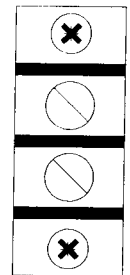

C&K 7201J37

C&K KEY SW

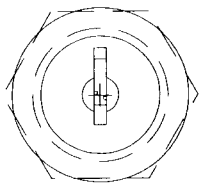

ROTARY SW W/ 7/8" KNOB

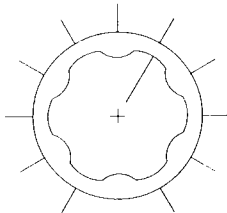

POT W/ 7/8" KNOB

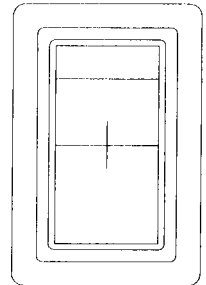
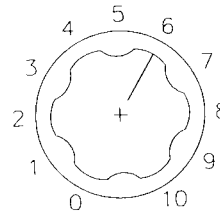

**Momentary
Pushbutton
SPST 903**

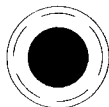

EAO 31

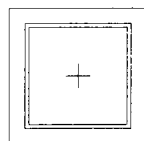

C&K 8121

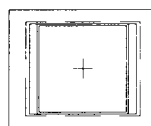

DIALIGHT 554

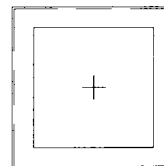

C&K 7201J51

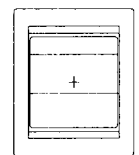

ALCO MTA

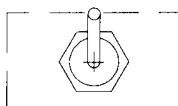

C-H 8373

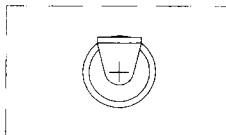

LED



RCI
CUSTOM
801 North East Street
Frederick, MD 21701
PHONE 301-620-9130
FAX 301-620-9103

PROJECT		
DR	PN	DRAWING NO.
SCALE FULL		

Refer to RCI Custom Catalog pages 24-27 for additional connector options.

STEP 1.

Make copies of rack panels and half scale symbols on pages 18 & 19.

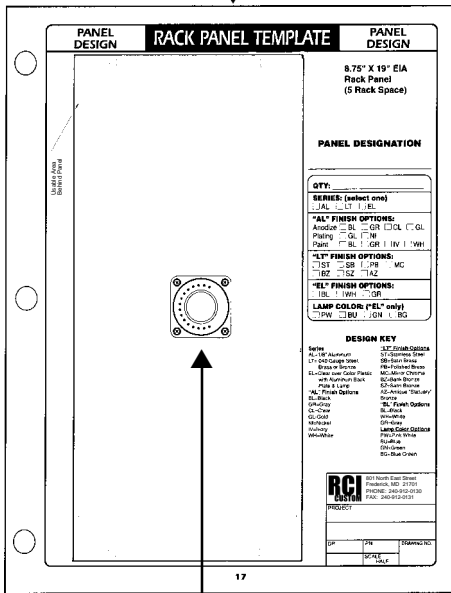

STEP 2.

Trace or Paste

Place the symbol page under the copy of the rack panel and trace the devices on the blank plate at the desired location

OR

cut out the appropriate devices from the copy of the symbol page and paste them on the blank plate at the desired location.

*Be sure to note device sizes and usable area of rack panel.

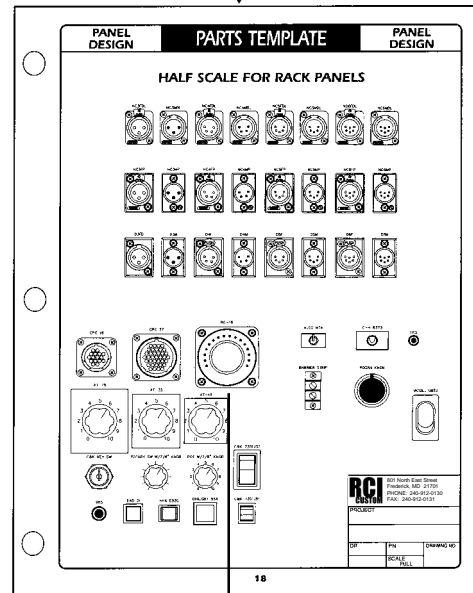

STEP 3.

Write in text to be engraved on panel. If the panel has multiple quantities, indicate subsequent engraving.

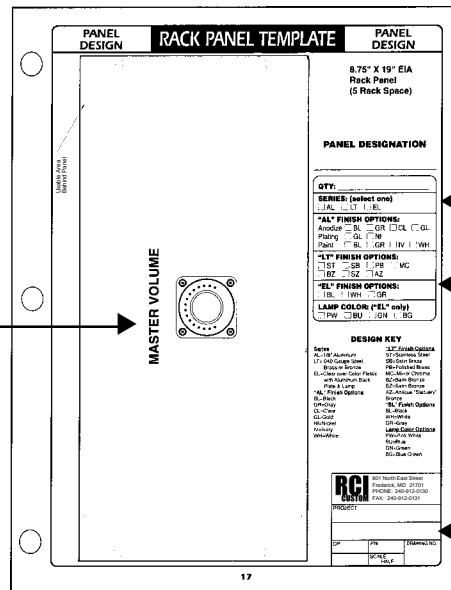

STEP 4.

Indicate panel designation, quantity, and finish type, and any other additional engraving or silkscreening requirements. Fill title block with appropriate information, if desired.

STEP 5.

Fax completed panel design to our AVD Sales Department for quotation.

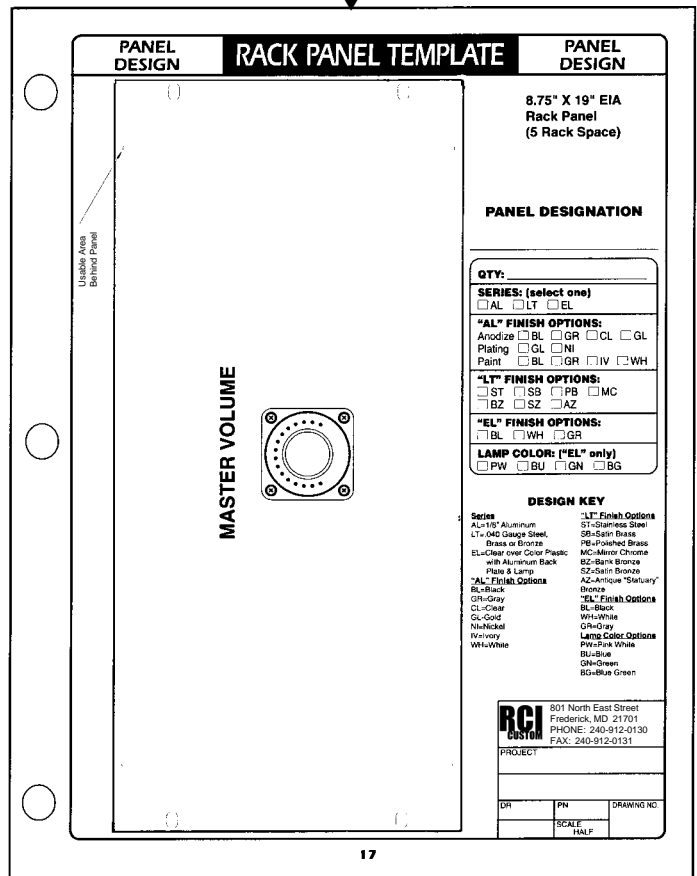

1.75" X 19" EIA
Rack Panel
(1 Rack Space)

Usable Area
Behind Panel

PANEL DESIGNATION

QTY: _____
SERIES: (select one) <input type="checkbox"/> AL <input type="checkbox"/> LT <input type="checkbox"/> EL
"AL" FINISH OPTIONS: Anodize <input type="checkbox"/> BL <input type="checkbox"/> GR <input type="checkbox"/> CL <input type="checkbox"/> GL Plating <input type="checkbox"/> GL <input type="checkbox"/> NI Paint <input type="checkbox"/> BL <input type="checkbox"/> GR <input type="checkbox"/> IV <input type="checkbox"/> WH
"LT" FINISH OPTIONS: <input type="checkbox"/> ST <input type="checkbox"/> SB <input type="checkbox"/> PB <input type="checkbox"/> MC <input type="checkbox"/> BZ <input type="checkbox"/> SZ <input type="checkbox"/> AZ
"EL" FINISH OPTIONS: <input type="checkbox"/> BL <input type="checkbox"/> WH <input type="checkbox"/> GR
LAMP COLOR: ("EL" only) <input type="checkbox"/> PW <input type="checkbox"/> BU <input type="checkbox"/> GN <input type="checkbox"/> BG

DESIGN KEY

- Series**
 AL=1/8" Aluminum
 LT=.040 Gauge Steel,
 Brass or Bronze
 EL=Clear over Color Plastic with
 Aluminum Back Plate & Lamp
- "AL" Finish Options**
 BL=Black
 GR=Gray
 CL=Clear
 GL=Gold
 NI=Nickel
 IV=Ivory
 WH=White
- "LT" Finish Options**
 ST=Stainless Steel
 SB=Satin Brass
 PB=Polished Brass
 MC=Mirror Chrome
 BZ=Bank Bronze
 SZ=Satin Bronze
 AZ=Antique "Statuary" Bronze
- "EL" Finish Options**
 BL=Black
 WH=White
 GR=Gray
- Lamp Color Options**
 PW=Pink White
 BU=Blue
 GN=Green
 BG=Blue Green

RCI CUSTOM		801 North East Street Frederick, MD 21701 PHONE 301-620-9130 FAX 301-620-9103
PROJECT _____		
DR _____	PN _____	DRAWING NO. _____
SCALE HALF		

**3.5" X 19" EIA
Rack Panel
(2 Rack Space)**

Usable Area
Behind Panel

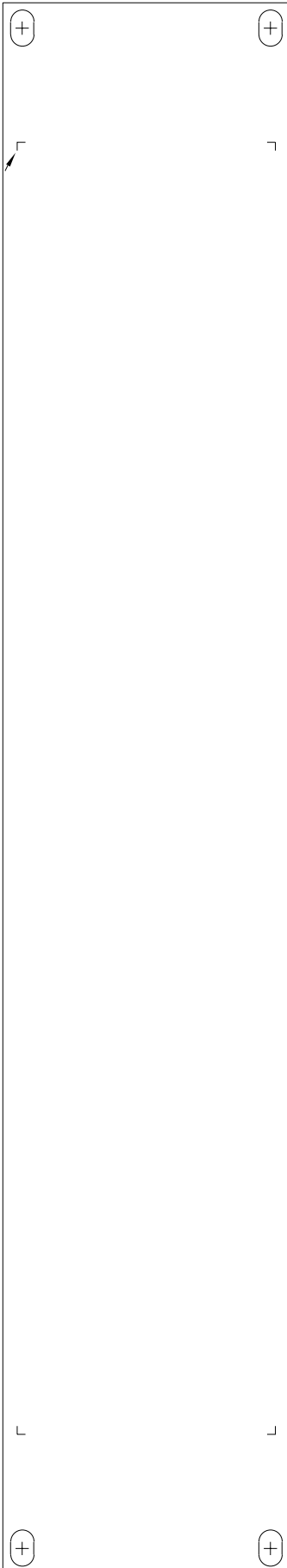

PANEL DESIGNATION

QTY: _____
SERIES: (select one) <input type="checkbox"/> AL <input type="checkbox"/> LT <input type="checkbox"/> EL
"AL" FINISH OPTIONS: Anodize <input type="checkbox"/> BL <input type="checkbox"/> GR <input type="checkbox"/> CL <input type="checkbox"/> GL Plating <input type="checkbox"/> GL <input type="checkbox"/> NI Paint <input type="checkbox"/> BL <input type="checkbox"/> GR <input type="checkbox"/> IV <input type="checkbox"/> WH
"LT" FINISH OPTIONS: <input type="checkbox"/> ST <input type="checkbox"/> SB <input type="checkbox"/> PB <input type="checkbox"/> MC <input type="checkbox"/> BZ <input type="checkbox"/> SZ <input type="checkbox"/> AZ
"EL" FINISH OPTIONS: <input type="checkbox"/> BL <input type="checkbox"/> WH <input type="checkbox"/> GR
LAMP COLOR: ("EL" only) <input type="checkbox"/> PW <input type="checkbox"/> BU <input type="checkbox"/> GN <input type="checkbox"/> BG

DESIGN KEY

Series

AL=1/8" Aluminum
 LT=.040 Gauge Steel,
 Brass or Bronze
 EL=Clear over Color Plastic
 with Aluminum Back
 Plate & Lamp

"AL" Finish Options

BL=Black
 GR=Gray
 CL=Clear
 GL=Gold
 NI=Nickel
 IV=Ivory
 WH=White

"LT" Finish Options

ST=Stainless Steel
 SB=Satin Brass
 PB=Polished Brass
 MC=Mirror Chrome
 BZ=Bank Bronze
 SZ=Satin Bronze
 AZ=Antique "Statuary"
 Bronze

"EL" Finish Options

BL=Black
 WH=White
 GR=Gray

Lamp Color Options

PW=Pink White
 BU=Blue
 GN=Green
 BG=Blue Green

RCI CUSTOM			801 North East Street Frederick, MD 21701 PHONE 301-620-9130 FAX 301-620-9103
PROJECT			
DR	PN	DRAWING NO.	
	SCALE HALF		

5.25" X 19" EIA
 Rack Panel
 (3 Rack Space)

Usable Area
 Behind Panel

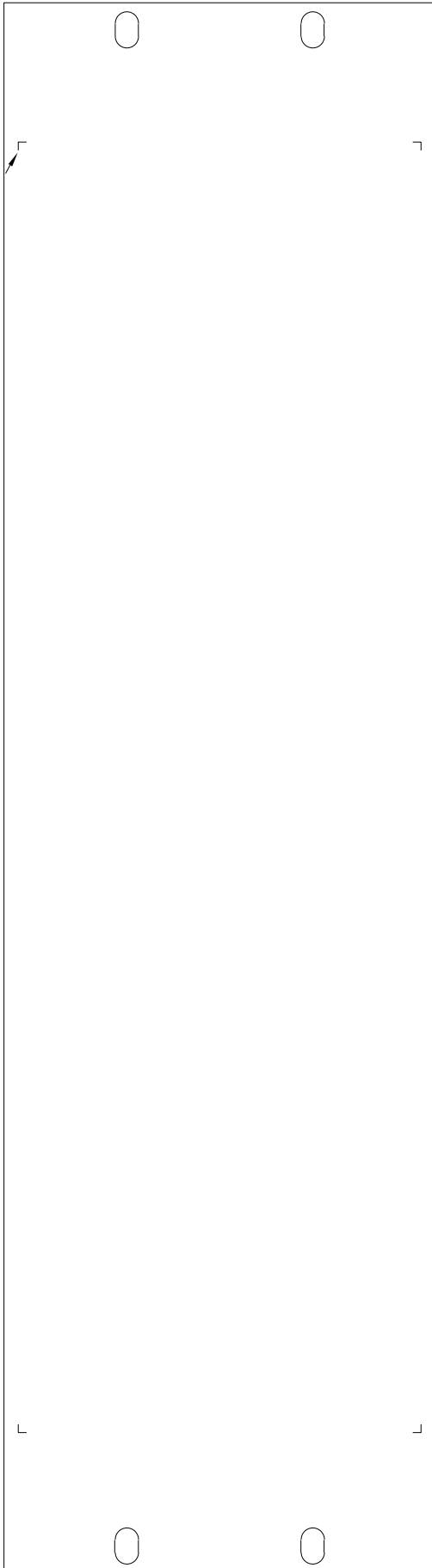

PANEL DESIGNATION

QTY: _____
SERIES: (select one) <input type="checkbox"/> AL <input type="checkbox"/> LT <input type="checkbox"/> EL
"AL" FINISH OPTIONS: Anodize <input type="checkbox"/> BL <input type="checkbox"/> GR <input type="checkbox"/> CL <input type="checkbox"/> GL Plating <input type="checkbox"/> GL <input type="checkbox"/> NI Paint <input type="checkbox"/> BL <input type="checkbox"/> GR <input type="checkbox"/> IV <input type="checkbox"/> WH
"LT" FINISH OPTIONS: <input type="checkbox"/> ST <input type="checkbox"/> SB <input type="checkbox"/> PB <input type="checkbox"/> MC <input type="checkbox"/> BZ <input type="checkbox"/> SZ <input type="checkbox"/> AZ
"EL" FINISH OPTIONS: <input type="checkbox"/> BL <input type="checkbox"/> WH <input type="checkbox"/> GR
LAMP COLOR: ("EL" only) <input type="checkbox"/> PW <input type="checkbox"/> BU <input type="checkbox"/> GN <input type="checkbox"/> BG

DESIGN KEY

- | | |
|---|---|
| Series
AL=1/8" Aluminum
LT=.040 Gauge Steel,
Brass or Bronze
EL=Clear over Color Plastic
with Aluminum Back
Plate & Lamp | "LT" Finish Options
ST=Stainless Steel
SB=Satin Brass
PB=Polished Brass
MC=Mirror Chrome
BZ=Bank Bronze
SZ=Satin Bronze
AZ=Antique "Statuary"
Bronze |
| "AL" Finish Options
BL=Black
GR=Gray
CL=Clear
GL=Gold
NI=Nickel
IV=Ivory
WH=White | "EL" Finish Options
BL=Black
WH=White
GR=Gray
Lamp Color Options
PW=Pink White
BU=Blue
GN=Green
BG=Blue Green |

RCI CUSTOM			801 North East Street Frederick, MD 21701 PHONE 301-620-9130 FAX 301-620-9103		
PROJECT					
DR	PN	DRAWING NO.			
SCALE					
HALF					

**7" X 19" EIA
Rack Panel
(4 Rack Space)**

PANEL DESIGNATION

QTY: _____

SERIES: (select one)

AL LT EL

"AL" FINISH OPTIONS:

Anodize BL GR CL GL
 Plating GL NI
 Paint BL GR IV WH

"LT" FINISH OPTIONS:

ST SB PB MC
 BZ SZ AZ

"EL" FINISH OPTIONS:

BL WH GR

LAMP COLOR: ("EL" only)

PW BU GN BG

DESIGN KEY

Series

AL=1/8" Aluminum
 LT=.040 Gauge Steel,
 Brass or Bronze
 EL=Clear over Color Plastic
 with Aluminum Back
 Plate & Lamp

"AL" Finish Options

BL=Black
 GR=Gray
 CL=Clear
 GL=Gold
 NI=Nickel
 IV=Ivory
 WH=White

"LT" Finish Options

ST=Stainless Steel
 SB=Satin Brass
 PB=Polished Brass
 MC=Mirror Chrome
 BZ=Bank Bronze
 SZ=Satin Bronze
 AZ=Antique "Statuary"
 Bronze

"EL" Finish Options

BL=Black
 WH=White
 GR=Gray

Lamp Color Options

PW=Pink White
 BU=Blue
 GN=Green
 BG=Blue Green

Usable Area
Behind Panel

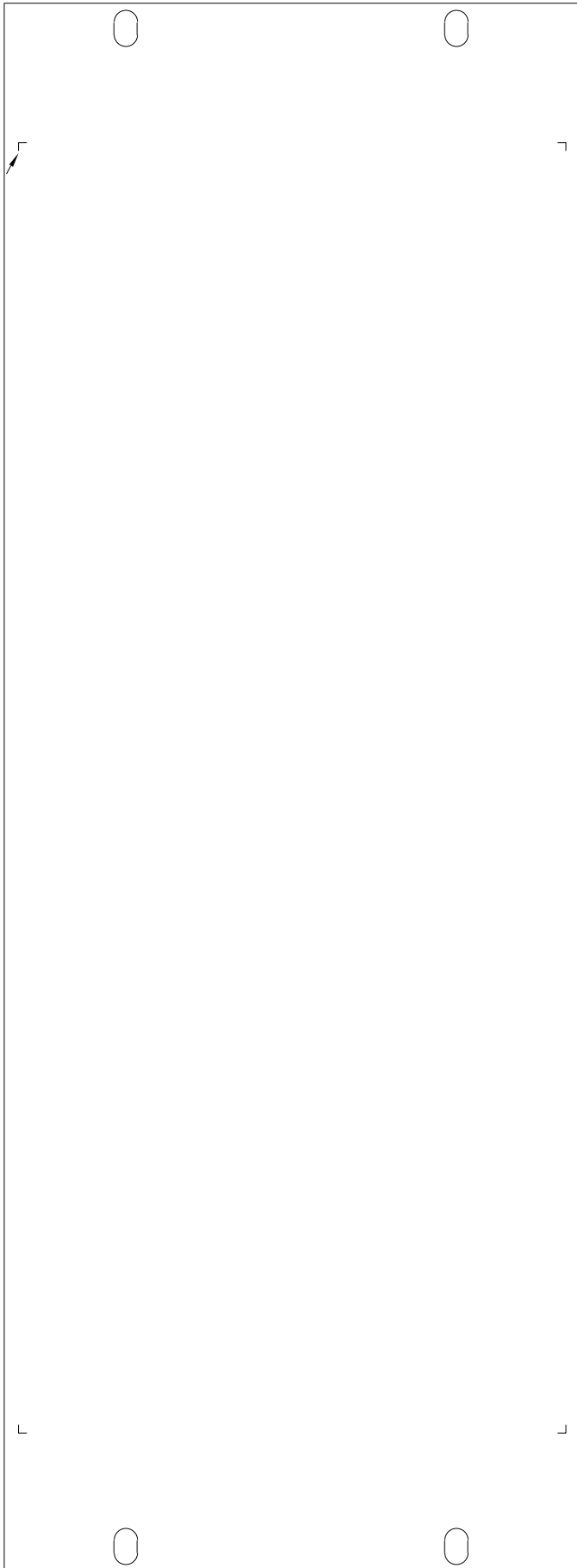

 801 North East Street Frederick, MD 21701 PHONE 301-620-9130 FAX 301-620-9103		
DR	PN	DRAWING NO.
SCALE HALF		

Usable Area Behind Panel

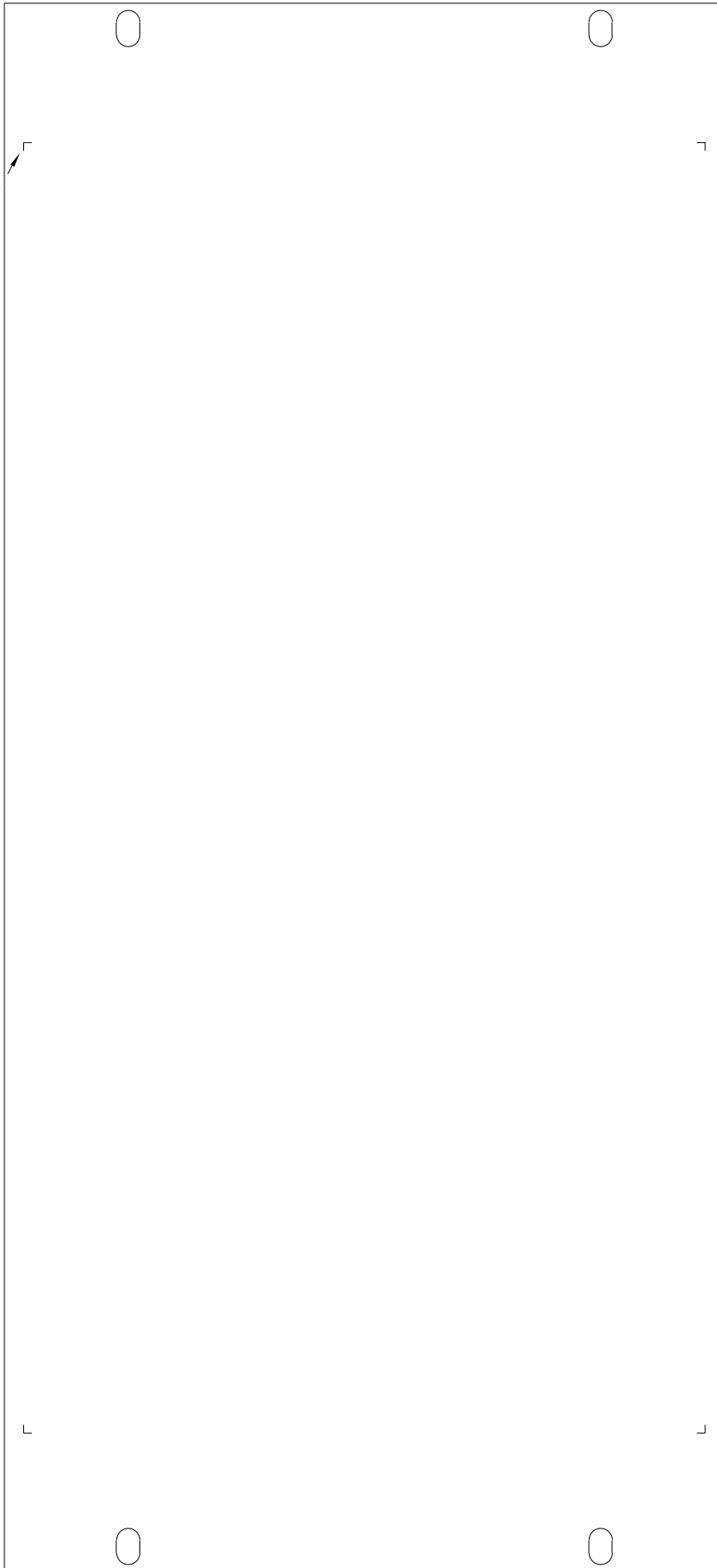

**8.75" X 19" EIA
Rack Panel
(5 Rack Space)**

PANEL DESIGNATION

QTY: _____
SERIES: (select one) <input type="checkbox"/> AL <input type="checkbox"/> LT <input type="checkbox"/> EL
"AL" FINISH OPTIONS: Anodize <input type="checkbox"/> BL <input type="checkbox"/> GR <input type="checkbox"/> CL <input type="checkbox"/> GL Plating <input type="checkbox"/> GL <input type="checkbox"/> NI Paint <input type="checkbox"/> BL <input type="checkbox"/> GR <input type="checkbox"/> IV <input type="checkbox"/> WH
"LT" FINISH OPTIONS: <input type="checkbox"/> ST <input type="checkbox"/> SB <input type="checkbox"/> PB <input type="checkbox"/> MC <input type="checkbox"/> BZ <input type="checkbox"/> SZ <input type="checkbox"/> AZ
"EL" FINISH OPTIONS: <input type="checkbox"/> BL <input type="checkbox"/> WH <input type="checkbox"/> GR
LAMP COLOR: ("EL" only) <input type="checkbox"/> PW <input type="checkbox"/> BU <input type="checkbox"/> GN <input type="checkbox"/> BG

DESIGN KEY

- | | | | |
|---|---|---|---|
| Series
AL=1/8" Aluminum
LT=.040 Gauge Steel,
Brass or Bronze
EL=Clear over Color Plastic
with Aluminum Back
Plate & Lamp | "AL" Finish Options
BL=Black
GR=Gray
CL=Clear
GL=Gold
NI=Nickel
IV=Ivory
WH=White | "LT" Finish Options
ST=Stainless Steel
SB=Satin Brass
PB=Polished Brass
MC=Mirror Chrome
BZ=Bank Bronze
SZ=Satin Bronze
AZ=Antique "Statuary"
Bronze | "EL" Finish Options
BL=Black
WH=White
GR=Gray
Lamp Color Options
PW=Pink White
BU=Blue
GN=Green
BG=Blue Green |
|---|---|---|---|

RCI
CUSTOM
801 North East Street
Frederick, MD 21701
PHONE 301-620-9130
FAX 301-620-9103

PROJECT		
DR	PN	DRAWING NO.
	SCALE HALF	

HALF SCALE FOR RACK PANELS

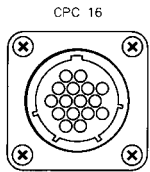
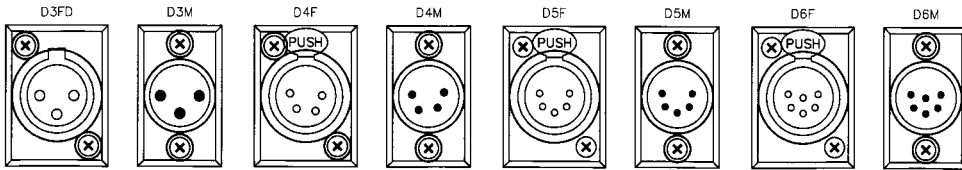
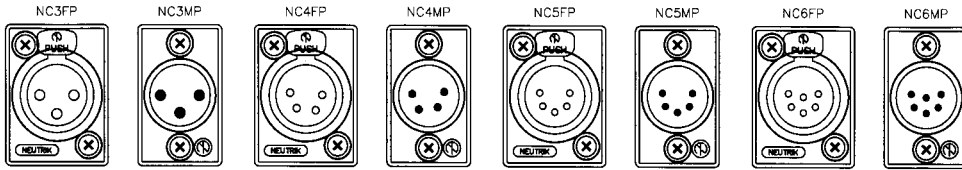
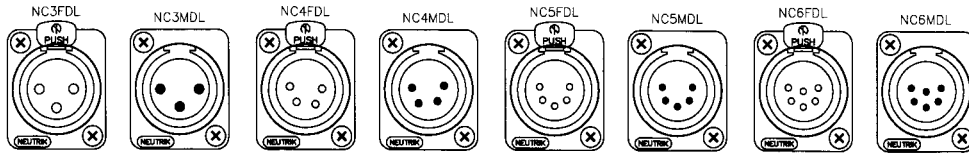

CPC 16

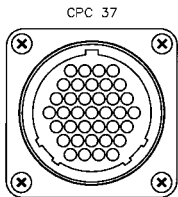

CPC 37

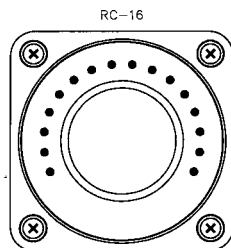

RC-16



ALCO MTA

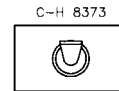

C-H 8373



LED

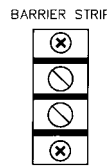

BARRIER STRIP

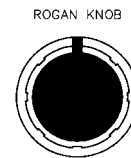

ROGAN KNOB

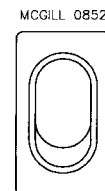

MCGILL 0852

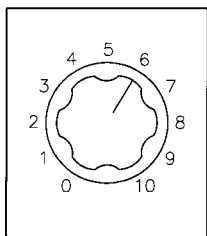

AT-75

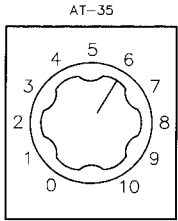

AT-35

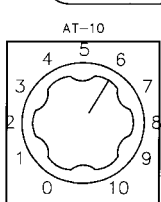

AT-10



C&K KEY SW

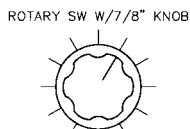

ROTARY SW W/7/8" KNOB

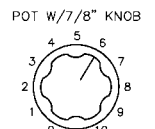

POT W/7/8" KNOB

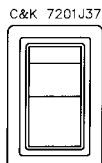

C&K 7201J37



Momentary Pushbutton SPST 903



EAO 31



NKK EB20



DIALIGHT 554



C&K 7201J51

RCI CUSTOM
 801 North East Street
 Frederick, MD 21701
 PHONE 301-620-9130
 FAX 301-620-9103

PROJECT		
DR	PN	DRAWING NO.
SCALE HALF		

HALF SCALE FOR RACK PANELS

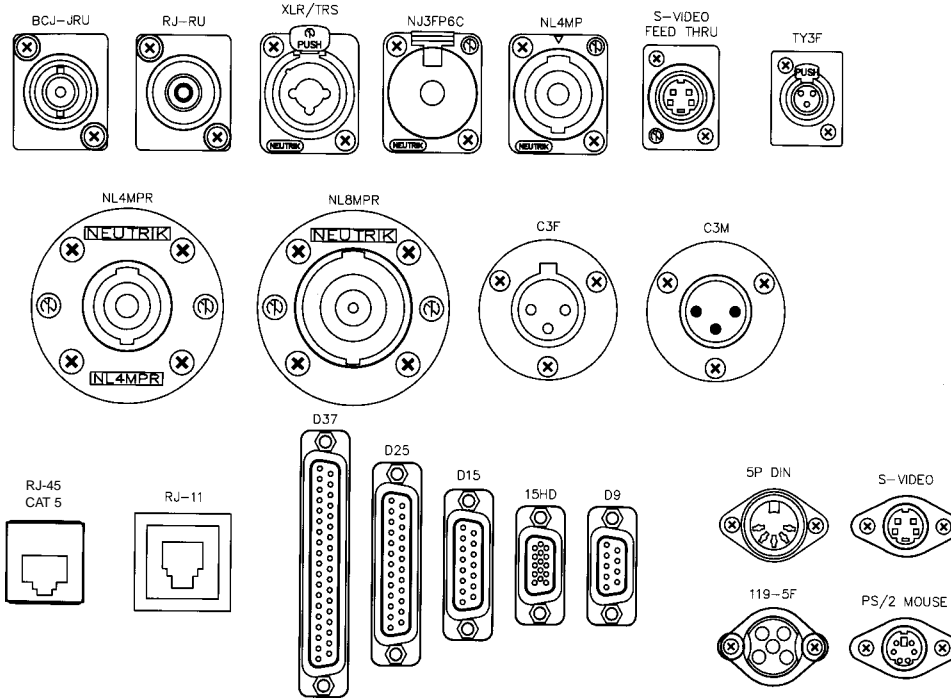

Specify solder type, feedthrough, or crimp.

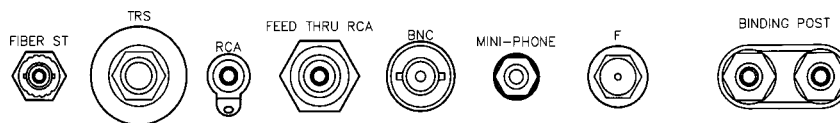

Refer to RCI Custom Catalog pages 24-27 for additional connector options.

RCI CUSTOM			801 North East Street Frederick, MD 21701 PHONE 301-620-9130 FAX 301-620-9103
PROJECT			
DR	PN	DRAWING NO.	
	SCALE HALF		

CUSTOM CHASSIS

MOUNTS TO 19" EIA STANDARD RACK PANEL

STANDARD SIZES

CH-X-Y

HEIGHT = "X"
PANEL SIZE

- 1 RU = 1
- 2 RU = 2
- 3 RU = 3
- 4 RU = 4
- 5 RU = 5
- 6 RU = 6

DEPTH = "Y"
ACTUAL SIZE

- 5 = 5"
- 7 = 7"
- 9 = 9"

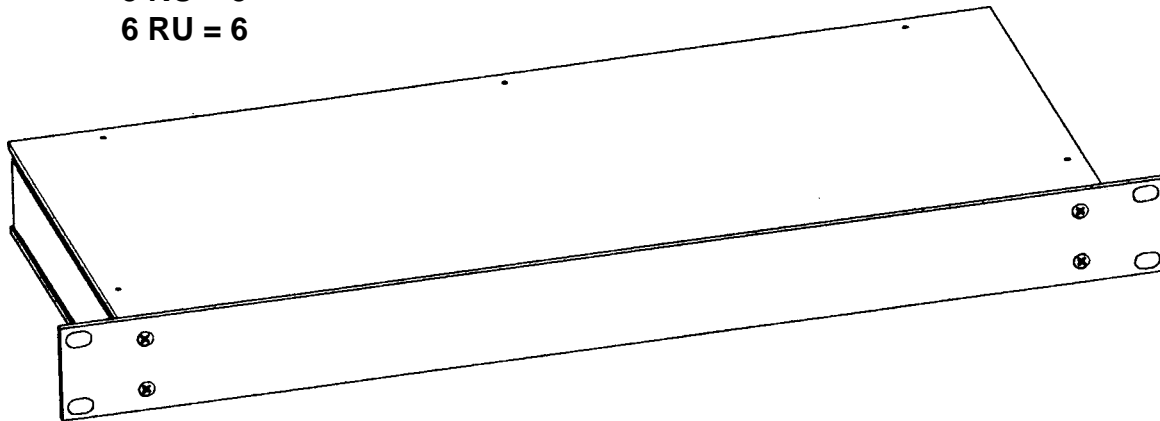

SPECIFICATIONS

WIDTH (ASSEMBLED) - 17"

MATERIAL - 1/16" T6 ALUMINUM

FINISH - GOLD ALODINE

FRONT AND REAR PANELS MOUNT VIA #6-32
SCREWS INTO PEM-NUTS FASTENED INTO
THE SIDE PANELS.

TOP AND BOTTOM ARE FASTENED VIA #4
SHEET METAL SCREWS.

NOTE - FRONT PANEL MUST BE ORDERED SEPARATELY.
SEE PAGES 12-17